

HabasitLINK[®]

Installation instructions for belt types M2510, M2511, M2514, M2516

Please find full installation guide on www.habasitlink.com

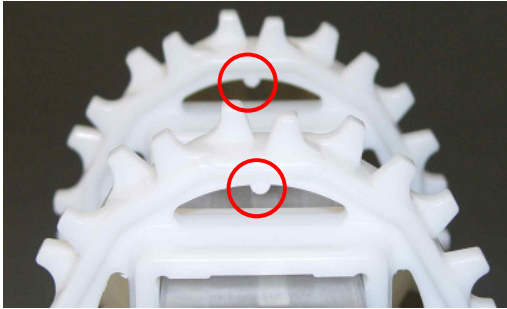

Sprocket alignment on the shafts:

Corresponding teeth axial aligned, check by alignment mark.

If the bore is square and the number of teeth can be divided by 4, there may be no mark.

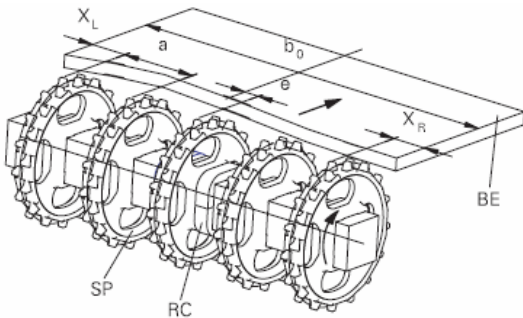

Sprockets Positioning:

Place sprockets between min. and max. spacing (a).

Respect edge distance X_L and X_R .

Offset (e) given by shaft design.

Fix only the sprocket in the middle with small clearance.

Belt type	Sprocket spacing a		Edge distance (minimal)	
	minimal mm inch	maximal mm inch	X_L mm inch	X_R mm inch
M2500	50 2	100 4	25 1	25 1

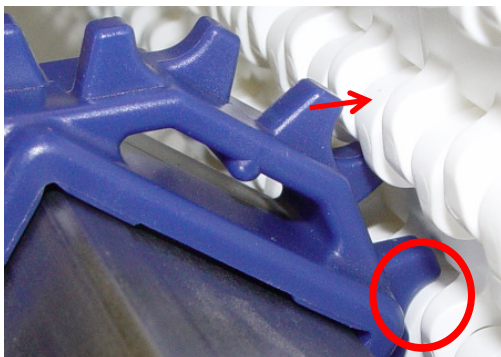

Check proper sprocket engagement:

The sprocket teeth must properly engage at the hinge.

Rod installation (snap fit rod retention):

Rod Ø5mm (0.2") with round shaped head must have a beveled end. If the belt is delivered in sections, join the sections with alternating rod head orientation e.g. on one section all rod heads on the left side and the following section all rod heads on the right hand side.

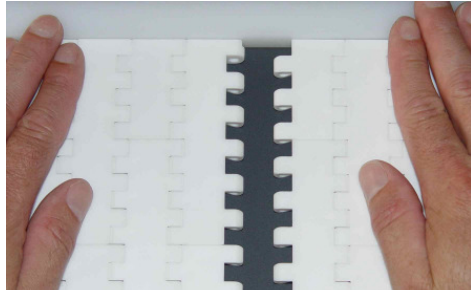

Pull belt sections together

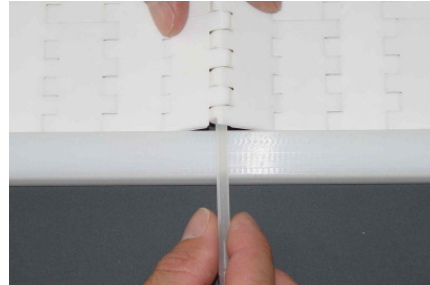

Insert rod

For easy rod installation, rod end must be beveled.

Check if rod head is fully embedded.

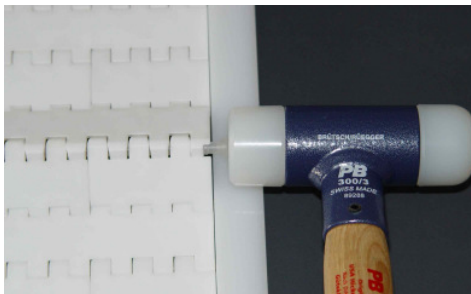

Hammer in the rod head

Rod removal (snap fit rod retention)

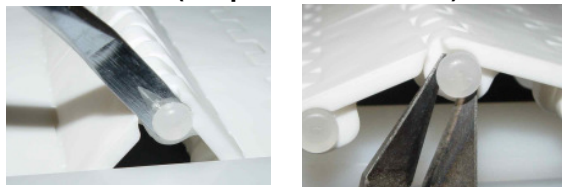

Leverage rod head out

Rod removal by Habasit rod removal tool (rod puller) or side cutter.

Do not cut off the rod head.

The belt must not be under tension.

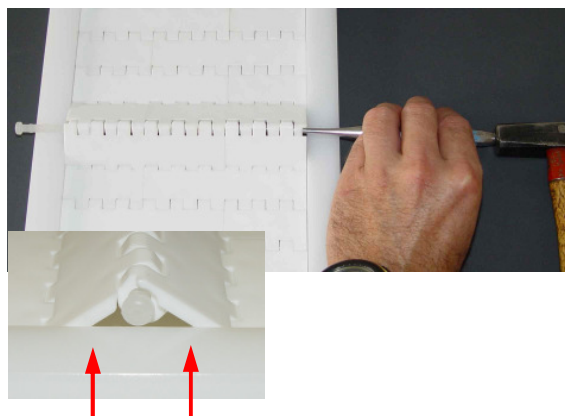

Rod removal (by hammer and punch)

Punch out of retaining head by striking rod end opposite to retaining head.

Hold back module edge on the opposite side.

The belt must not be under tension.

Product liability, application considerations

If the proper selection and application of Habasit products are not recommended by an authorized Habasit sales specialist, the selection and application of Habasit products, including the related area of product safety, are the responsibility of the customer. All indications / information are recommendations and believed to be reliable, but no representations, guarantees, or warranties of any kind are made as to their accuracy or suitability for particular applications. The data provided herein are based on laboratory work with small-scale test equipment, running at standard conditions, and do not necessarily match product performance in industrial use. New knowledge and experiences can lead to modifications and changes within a short time without prior notice.

BECAUSE CONDITIONS OF USE ARE OUTSIDE OF HABASIT'S AND ITS AFFILIATED COMPANIES' CONTROL, WE CANNOT ASSUME ANY LIABILITY CONCERNING THE SUITABILITY AND PROCESS ABILITY OF THE PRODUCTS MENTIONED HEREIN. THIS ALSO APPLIES TO PROCESS RESULTS / OUTPUT / MANUFACTURING GOODS AS WELL AS TO POSSIBLE DEFECTS, DAMAGES, CONSEQUENTIAL DAMAGES, AND FURTHER-REACHING CONSEQUENCES.

